

Differential pressure gauge

For the process industry, all-metal media chamber

Models 732.31, 733.31, 732.51 and 733.51

WIKA data sheet PM 07.05



for further approvals,
see page 7

Applications

- For gaseous and liquid aggressive media that are not highly viscous or crystallising, also in aggressive environments
- Pump monitoring and control
- Filter monitoring
- Level measurement on closed vessels

Special features

- Differential pressure measuring ranges from 0 ... 16 mbar to 0 ... 40 bar or 0 ... 10 inH₂O to 0 ... 600 psi
- High operating pressure (static pressure) up to 40 bar [600 psi]
- High overload safety up to 40 bar [600 psi]
- Models 732.31 and 733.31: Case with safety level "S3" per EN 837
- All-welded media chamber

Description

These differential pressure gauges are made of highly corrosion-resistant stainless steel and feature an all-metal media chamber to ensure long-term leak tightness (no elastomer sealing elements).

A high overload safety is achieved by the all-metal construction and the close-fitting design of the diaphragm measuring element.

The use of high-quality stainless steel materials and the robust design are geared to applications in the chemical and process engineering industries. Thus the instrument is suitable for liquid and gaseous media, also in aggressive environments.



Differential pressure gauge model 732.51

The low-temperature version POLARgauge® allows operation with ambient temperatures down to -70 °C [-94 °F].

Cases with safety level "S3" are fitted with a non-splintering window, a solid baffle wall between measuring system and dial and a blow-out back. In the event of a failure, the operator is protected at the front side, as media or components can only be ejected via the back of the case.

Scale ranges of 0 ... 16 mbar to 0 ... 40 bar or 0 ... 10 inH₂O to 0 ... 600 psi ensure the measuring ranges required for a wide variety of applications.

Functionality

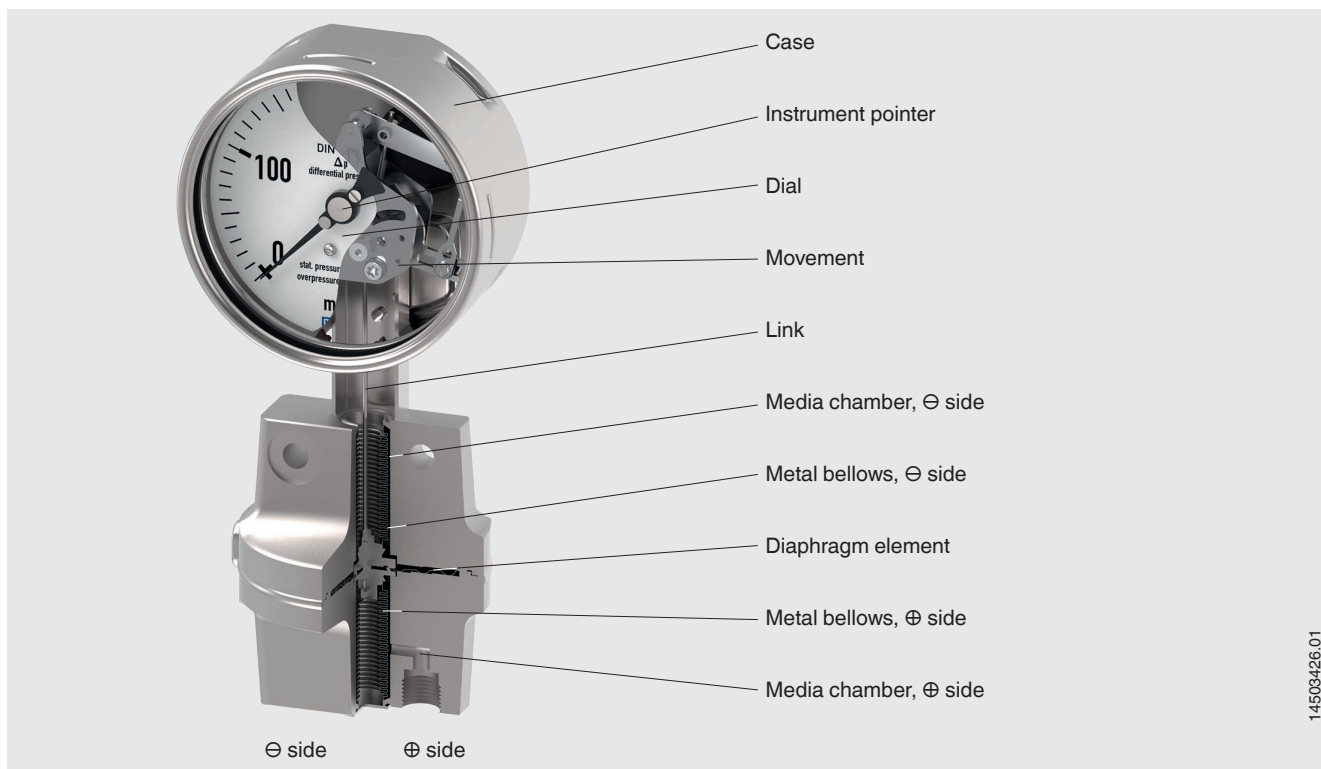

Design and operating principle

- Media chambers of the \oplus and \ominus side are separated by the diaphragm element
- Metal bellows isolate the media chambers from the atmosphere
- The pressure difference between \oplus and \ominus side leads to an axial pressure element deflection
- The deflection is transmitted to the movement via the link
- The movement converts the deflection into a pointer rotation

Overload safety

Diaphragm elements have a relatively large actuating force and, due to the annular clamping of the element, they are less sensitive to vibration in comparison with Bourdon tubes. Diaphragm elements can be subject to a higher overload of up to 10 times the full scale value, up to a max. of 40 bar, through load take-up points with metallic seating.

Overview of versions

Model	Case design		With case filling	Low-temperature version POLARgauge®
	Safety level "S3"	Safety level "S1"		
732.31	x			Selectable
733.31	x		x	Selectable
732.51		x		Selectable
733.51		x	x	Selectable

The above-mentioned versions can, optionally, be ordered with Ex approval.

→ For approvals and certificates, see page 7

Specifications

Basic information	
Standard	
Pressure measuring instruments for differential pressure	DIN 16003
→ For information on the “Selection, installation, handling and operation of pressure gauges”, see Technical information IN 00.05.	
Further version	<ul style="list-style-type: none"> ■ Oil- and grease-free ■ For oxygen, oil- and grease-free ■ Silicone-free ■ Per NACE ¹⁾ MR0175 / ISO 15156, use in H₂S-containing environments in oil and gas production ■ Per NACE ¹⁾ MR0103 / ISO 17945, metals resistant to hydrogen sulphide stress cracking ■ With pre-volume deflagration flame arrester ²⁾ for mounting to zone 0 (EPL Ga); model 910.21; see data sheet AC 91.02
Nominal size (NS)	<ul style="list-style-type: none"> ■ Ø 100 mm [4"] ■ Ø 160 mm [6"]
Window	Laminated safety glass
Connection location	Lower mount (radial) Other connection locations on request
Case	
Design	<ul style="list-style-type: none"> ■ Safety level “S1” per EN 837-1: With blow-out device ■ Safety level “S3” per EN 837-1: With solid baffle wall and blow-out back
Material	<ul style="list-style-type: none"> ■ Stainless steel 1.4301 (304 SS) ■ Stainless steel 1.4571 (316 Ti)
Case filling ³⁾	<ul style="list-style-type: none"> ■ Without ■ Silicone oil Instruments with case filling with compensating valve to vent and reseal case.
Venting of the media chambers	
Span ≤ 0.25 bar [100 inH ₂ O]	With venting
Span > 0.25 bar [100 inH ₂ O]	<ul style="list-style-type: none"> ■ Without ■ With venting
Movement	Stainless steel

1) General information about NACE standards; see data sheet IN 00.21

2) Only for instruments with Ex approval

3) Ingress protection IP65 for instruments with case filling

Measuring element	
Type of measuring element	Diaphragm element
Material	
Span ≤ 0.25 bar [100 inH ₂ O]	Stainless steel 1.4571 (316 Ti)
Span > 0.25 bar [100 inH ₂ O]	NiCr alloy (Inconel)

Accuracy specifications	
Accuracy class	<ul style="list-style-type: none"> ■ 1.6 ■ 1.0 ■ 2.5
Zero point setting	
Instruments with case filling ¹⁾	<ul style="list-style-type: none"> ■ Without ■ External setting
Instruments without case filling	<ul style="list-style-type: none"> ■ Without ■ Setting by means of adjustable pointer
Influence of static pressure	
Span ≤ 0.25 bar [100 inH ₂ O]	±0.3 %/1 bar [14.5 psi]
Span > 0.25 bar [100 inH ₂ O]	±0.04 %/1 bar [14.5 psi]
Temperature error	On deviation from the reference conditions at the measuring system: ≤ ±0.5 % per 10 °C [≤ ±0.5 % per 18 °F] of full scale value
Reference conditions	
Ambient temperature	+20 °C [+68 °F]

1) Except for model 733.31, setting possible by means of adjustable pointer

Scale ranges

mbar		
0 ... 16 ¹⁾	0 ... 160	0 ... 1,000
0 ... 25	0 ... 250	0 ... 1,100
0 ... 40	0 ... 300	0 ... 1,200
0 ... 60	0 ... 400	0 ... 1,600
0 ... 100	0 ... 600	0 ... 2,500

bar		
0 ... 0.25	0 ... 4	0 ... 20
0 ... 0.4	0 ... 6	0 ... 25
0 ... 0.6	0 ... 7	0 ... 30
0 ... 1	0 ... 10	0 ... 40
0 ... 1.6	0 ... 14	
0 ... 2.5	0 ... 16	

kPa		
0 ... 1.6 ¹⁾	0 ... 40	0 ... 700
0 ... 2.5	0 ... 60	0 ... 800
0 ... 4	0 ... 100	0 ... 1,000
0 ... 6	0 ... 160	0 ... 1,400
0 ... 10	0 ... 250	0 ... 1,600
0 ... 16	0 ... 300	0 ... 2,500
0 ... 25	0 ... 400	
0 ... 30	0 ... 600	

inH ₂ O		
0 ... 10 ¹⁾	0 ... 30	0 ... 150
0 ... 15	0 ... 40	0 ... 200
0 ... 20	0 ... 60	0 ... 250
0 ... 25	0 ... 100	

psi		
0 ... 6	0 ... 60	0 ... 250
0 ... 8	0 ... 100	0 ... 300
0 ... 10	0 ... 150	0 ... 400
0 ... 15	0 ... 160	0 ... 600
0 ... 30	0 ... 200	

Vacuum and +/- scale ranges

mbar		
-16 ... 0 ¹⁾	-600 ... 0	-50 ... +50
-25 ... 0	-1,000 ... 0	-80 ... +80
-40 ... 0	-1,100 ... 0	-125 ... +125
-60 ... 0	-1,200 ... 0	-200 ... +200
-100 ... 0	-8 ... +8	-300 ... +300
-160 ... 0	-10 ... +15	-500 ... +500
-250 ... 0	-20 ... +20	-600 ... +400
-400 ... 0	-30 ... +30	-1,000 ... +600

psi	
-15 ... 0 inHg	-30 inHg ... +300
-30 ... 0 inHg	-5 ... +5
-30 inHg ... +15	-15 ... +15
-30 inHg ... +30	-30 ... +30
-30 inHg ... +60	-50 ... +50
-30 inHg ... +100	-100 ... +100
-30 inHg ... +160	-150 ... +150
-30 inHg ... +200	

bar		
-0.6 ... 0	-1 ... +1.5	-1 ... +9
-1 ... 0	-1 ... +3	-1 ... +15
-1 ... +0.6	-1 ... +5	-1 ... +24

kPa		
-60 ... 0	-15 ... +15	-100 ... +500
-100 ... 0	-20 ... +40	-100 ... +700
-2 ... +4	-100 ... +60	-100 ... +900
-4 ... +6	-100 ... +100	-100 ... +1,000
-6 ... +4	-100 ... +150	-100 ... +1,500
-6 ... +10	-100 ... +200	-100 ... +2,400
-10 ... +6	-100 ... +300	
-10 ... +15	-100 ... +400	

1) Scale angle approx. 180°, with all other scale ranges the scale angle is 270°.

Other scale ranges on request

Further details on: Scale ranges		
Unit	<input type="checkbox"/> mbar <input type="checkbox"/> bar <input type="checkbox"/> psi <input type="checkbox"/> kPa <input type="checkbox"/> MPa <input type="checkbox"/> mmH ₂ O <input type="checkbox"/> inH ₂ O <input type="checkbox"/> kg/cm ² <input type="checkbox"/> oz/cm ² Other units on request	
Overload safety and max. operating pressure (static pressure)	The possibility of selection depends on the scale range. → See separate table	
Dial		
Scale layout	<input type="checkbox"/> Single scale <input type="checkbox"/> Dual scale	
Scale colour	Single scale	Black
	Dual scale	Black/red
Material	Aluminium	
Customer-specific version	<input type="checkbox"/> Without <input type="checkbox"/> With special scale, e.g. linear pressure or square root incrementation Other scales, e.g. with red mark, circular arcs or circular sectors, on request → Alternatively, adhesive label set for red and green circular arcs; see data sheet AC 08.03	
Pointer		
Instrument pointer	With case filling	Standard pointer, aluminium, black
	Without case filling	Adjustable pointer, aluminium, black
Mark pointer/drag pointer	<input type="checkbox"/> Without <input type="checkbox"/> Mark pointer on bayonet ring, adjustable	
Pointer stop pin	<input type="checkbox"/> Without <input type="checkbox"/> At 6 o'clock	

Overload safety and max. operating pressure (static pressure)	
Scale range	Overload safety / max. operating pressure (static) Either side max.
0 ... 16 to 0 ... 40 mbar [0 ... 10 to 0 ... 16 inH ₂ O]	<ul style="list-style-type: none"> ■ 2.5 bar [36 psi] / 2.5 bar [36 psi] ■ 2.5 bar [36 psi] / 6 bar [87 psi]
0 ... 60 to 0 ... 250 mbar [0 ... 25 to 0 ... 100 inH ₂ O]	<ul style="list-style-type: none"> ■ 2.5 bar [36 psi] / 6 bar [87 psi] ■ 6 bar [87 psi] / 10 bar [145 psi]
0 ... 400 mbar [0 ... 6 psi]	<ul style="list-style-type: none"> ■ 4 bar [58 psi] / 25 bar [363 psi] ■ 40 bar [600 psi] / 40 bar [600 psi]
0 ... 0.6 bar [0 ... 10 psi]	<ul style="list-style-type: none"> ■ 6 bar [87 psi] / 25 bar [363 psi] ■ 40 bar [600 psi] / 40 bar [600 psi]
0 ... 1 bar [0 ... 15 psi]	<ul style="list-style-type: none"> ■ 10 bar [145 psi] / 25 bar [363 psi] ■ 40 bar [600 psi] / 40 bar [600 psi]
0 ... 1.6 bar [0 ... 30 psi]	<ul style="list-style-type: none"> ■ 16 bar [232 psi] / 25 bar [363 psi] ■ 40 bar [600 psi] / 40 bar [600 psi]
0 ... 2.5 to 0 ... 40 bar [0 ... 60 to 0 ... 600 psi]	<ul style="list-style-type: none"> ■ 25 bar [363 psi] / 25 bar [363 psi] ■ 40 bar [600 psi] / 40 bar [600 psi]

Process connection		
Standard	<ul style="list-style-type: none"> ■ EN 837-1 ■ ANSI/B1.20.1 <p>→ For valve manifolds for an instrument hook-up, see "Accessories and spare parts".</p>	
Size		
EN 837-1	<ul style="list-style-type: none"> ■ 2 x G ¼, female thread ■ 2 x G ½ B, male thread 	
ANSI/B1.20.1	<ul style="list-style-type: none"> ■ 2 x ¼ NPT, female thread ■ 2 x ½ NPT, male thread 	
Restrictor	<ul style="list-style-type: none"> ■ Without ■ Ø 0.6 mm [0.024"], stainless steel ■ Ø 0.3 mm [0.012"], stainless steel 	
Material (wetted)		
Media chambers with process connection	Stainless steel 1.4571 (316 Ti)	
Venting of the media chambers	Stainless steel 1.4571 (316 Ti)	
Diaphragm element	Span ≤ 0.25 bar [100 inH ₂ O]	Stainless steel 1.4571 (316 Ti)
	Span > 0.25 bar [100 inH ₂ O]	NiCr alloy (Inconel)
Bellows	Stainless steel 1.4571 (316 Ti)	

Other process connections on request

Operating conditions	
Medium temperature range	<ul style="list-style-type: none"> ■ -20 ... +100 °C [-4 ... +212 °F] ■ -20 ... +120 °C [-4 ... +248 °F] ■ -20 ... +150 °C [-4 ... +284 °F]
Ambient temperature range	<ul style="list-style-type: none"> ■ -20 ... +60 °C [-4 ... +140 °F] ■ -40 ... +60 °C [-40 ... +140 °F] ¹⁾ ■ -70 ... +60 °C [-94 ... +140 °F] for low-temperature version POLARgauge®
Storage temperature range	-20 ... +60 °C [-4 ... 140 °F]
Pressure limitation	
Steady	Full scale value
Fluctuating	0.9 x full scale value
Ingress protection per IEC/EN 60529	<ul style="list-style-type: none"> ■ IP54 ■ IP65 ²⁾









1) Only selectable in combination with silicone oil case filling

2) Ingress protection IP65 for instruments with case filling

Approvals

Logo	Description	Region
	EU declaration of conformity	European Union
	RoHS directive	
-	CRN Safety (e.g. electr. safety, overpressure, ...)	Canada

Optional approvals

Logo	Description	Region
 	EU declaration of conformity	European Union
	ATEX directive Hazardous areas Gas II 2G Ex h IIC T6 ... T1 Gb X Dust II 2D Ex h IIIC T85 °C T450 °C Db X	
	EAC	Eurasian Economic Community
	Hazardous areas	
	Ex Ukraine Hazardous areas	Ukraine
	KCs Hazardous areas	Korea
	PAC Russia Metrology, measurement technology	Russia
	PAC Kazakhstan Metrology, measurement technology	Kazakhstan
-	MChS Permission for commissioning	Kazakhstan
	PAC Belarus Metrology, measurement technology	Belarus
	PAC Ukraine Metrology, measurement technology	Ukraine
-	PAC China Metrology, measurement technology	China

Certificates (option)

Certificates	
Certificates	<ul style="list-style-type: none"> ■ 2.2 test report per EN 10204 (e.g. state-of-the-art manufacturing, indication accuracy) ■ 3.1 inspection certificate per EN 10204 (e.g. material proof for wetted metal parts, indication accuracy)
Recommended calibration interval	1 year (dependent on conditions of use)

→ For approvals and certificates, see website

Dimensions in mm [in]

Process connection: 2 x G ¼, female thread

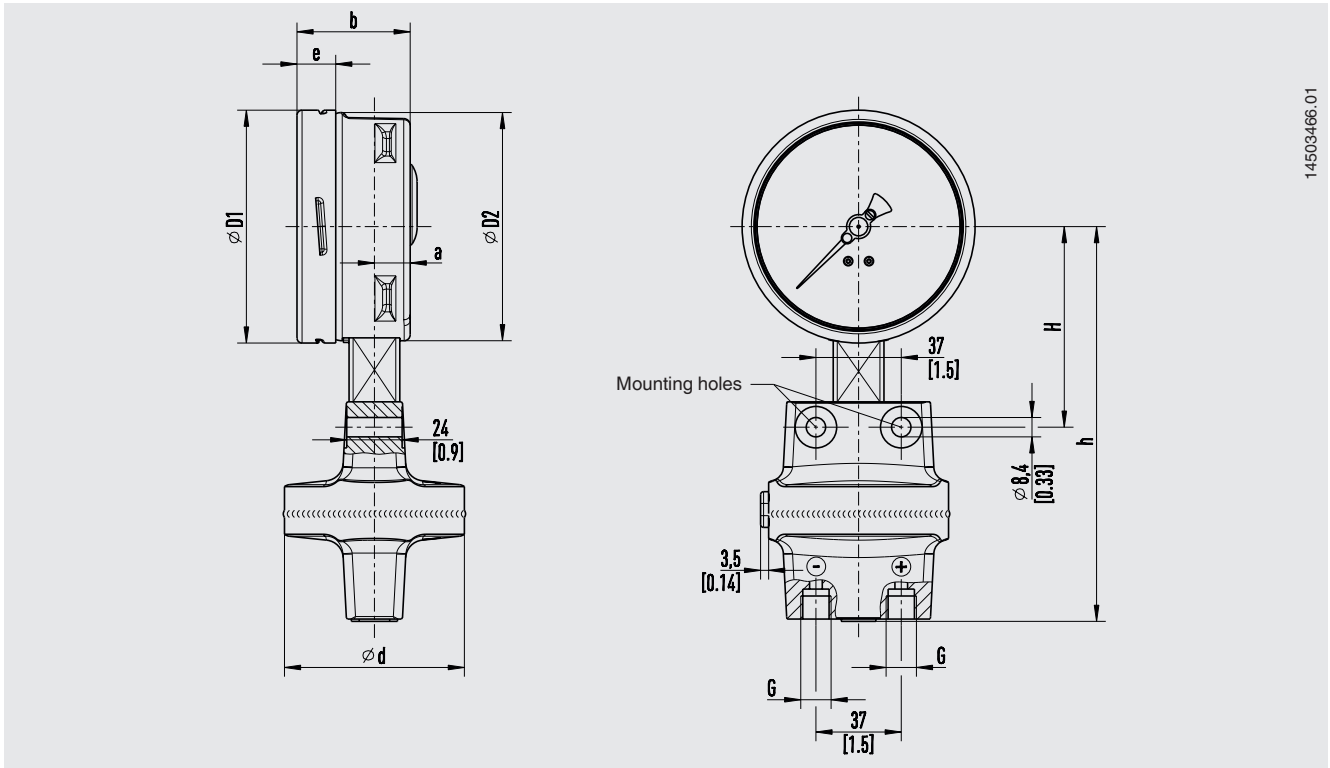

14503466.01



Models 732.31 and 733.31

NS	Span	G	Dimensions in mm [in]								Weight in kg [lb]
			a	b	D ₁	D ₂	d	e	h ±1	H	
100 [4"]	≤ 0.25 bar [100 inH ₂ O]	G ¼	23.5 [0.96]	59 [2.32]	101 [3.98]	99 [3.90]	140 [5.51]	17.5 [0.69]	160 [6.30]	90 [3.54]	2.70 [5.95]
	> 0.25 bar [100 inH ₂ O]	G ¼	23.5 [0.96]	59 [2.32]	101 [3.98]	99 [3.90]	78 [3.07]	17.5 [0.69]	170 [6.69]	87 [3.43]	1.90 [4.12]
160 [6"]	≤ 0.25 bar [100 inH ₂ O]	G ¼	23.5 [0.96]	59 [2.32]	161 [6.34]	159 [6.26]	140 [5.51]	17.5 [0.69]	190 [7.48]	120 [4.72]	3.40 [7.5]
	> 0.25 bar [100 inH ₂ O]	G ¼	23.5 [0.96]	59 [2.32]	161 [6.34]	159 [6.26]	78 [3.07]	17.5 [0.69]	200 [7.87]	117 [4.61]	2.40 [5.29]

Models 732.51 and 733.51

NS	Span	G	Dimensions in mm [in]								Weight in kg [lb]
			a	b	D ₁	D ₂	d	e	h ±1	H	
100 [4"]	≤ 0.25 bar [100 inH ₂ O]	G ¼	15.5 [0.61]	49.5 [1.95]	101 [3.98]	99 [3.90]	140 [5.51]	17.5 [0.69]	160 [6.30]	90 [3.54]	2.70 [5.95]
	> 0.25 bar [100 inH ₂ O]	G ¼	15.5 [0.61]	49.5 [1.95]	101 [3.98]	99 [3.90]	78 [3.07]	17.5 [0.69]	170 [6.69]	87 [3.43]	1.90 [4.12]
160 [6"]	≤ 0.25 bar [100 inH ₂ O]	G ¼	15.5 [0.61]	49.5 [1.95]	161 [6.34]	159 [6.26]	140 [5.51]	17.5 [0.69]	190 [7.48]	120 [4.72]	3.40 [7.5]
	> 0.25 bar [100 inH ₂ O]	G ¼	15.5 [0.61]	49.5 [1.95]	161 [6.34]	159 [6.26]	78 [3.07]	17.5 [0.69]	200 [7.87]	117 [4.61]	2.40 [5.29]

Accessories and spare parts

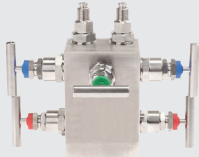
Model	Description	Order number
	910.33 Adhesive label set for red and green circular arcs → See data sheet AC 08.03	-
	NS 100 [4"]	14238945
	NS 160 [6"]	14228352
	910.17 Sealings → See data sheet AC 09.08	On request
	IV304 3-valve manifold Process connection / instrument connection: 2 x G ½, male thread / 2 x G ¼, male nut	37105018
	3-valve manifold Process connection / instrument connection: 2 x ½ NPT, male thread / 2 x G ¼, male nut	48752900
	IV504 5-valve manifold Process connection / instrument connection: 2 x G ½, male thread / 2 x G ¼, male nut	2020389
	5-valve manifold Process connection / instrument connection: 2 x ½ NPT, male thread / 2 x G ¼, male nut	81640336
	IV3x, IV5x Valve manifolds for differential pressure measuring instruments → See data sheet AC 09.23	On request
-	Instrument mounting bracket for wall or pipe mounting Steel, silver painted	1282999
-	Instrument mounting bracket for wall or pipe mounting Stainless steel	1473700

Accessories

Dimensions in mm [in]

Representation with mounting bracket for wall or pipe mounting and fitted 5-valve manifold

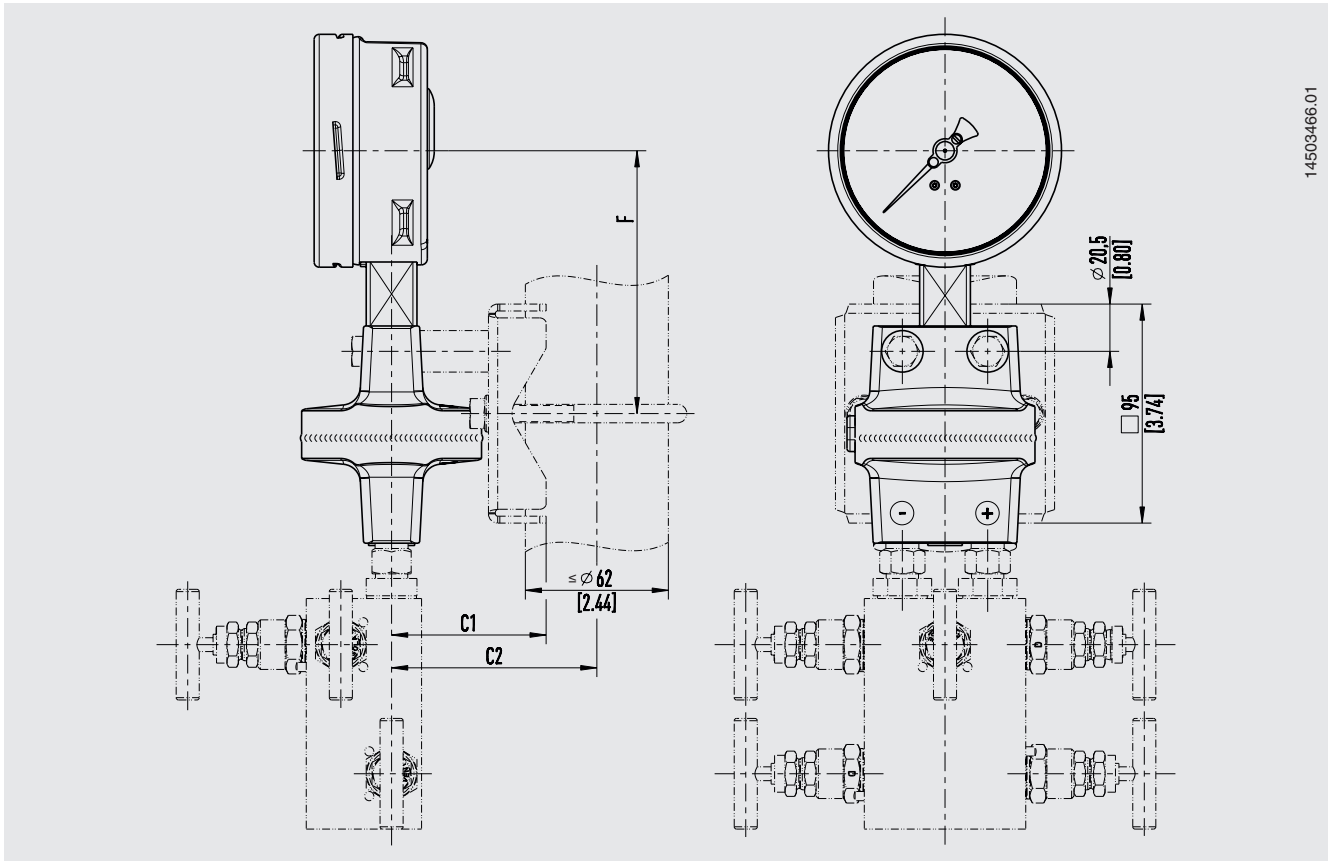

14503466.01

NS	Scale range	Dimensions in mm [in]		
		F	C1	C2
100 [4"]	≤ 0.25 bar [100 inH ₂ O]	114 [4.49]	96 [3.78]	118 [4.65]
	> 0.25 bar [100 inH ₂ O]	114 [4.49]	66 [2.60]	88 [3.46]
160 [6"]	≤ 0.25 bar [100 inH ₂ O]	144 [5.67]	96 [3.78]	118 [4.65]
	> 0.25 bar [100 inH ₂ O]	144 [5.67]	66 [2.60]	88 [3.46]

Ordering information

Model / Nominal size / Scale range / Scale layout (linear pressure or square root incrementation) / Max. operating pressure (static pressure) ... bar / Process connection / Connection location / Options

© 10/2008 WIKA Alexander Wiegand SE & Co. KG, all rights reserved.
The specifications given in this document represent the state of engineering at the time of publishing.
We reserve the right to make modifications to the specifications and materials.

